

We pre-drill all frames with inserts and we provide mounting screws with the frames; we do not pre-drill frames without inserts and we do not provide mounting screws.

Deco Frames

Deco Frames are offered as outside mount only. Each frame comes predrilled. Aluminum installation guide strip is provided with four-sided frame only.

3" Ridge Deco Frame

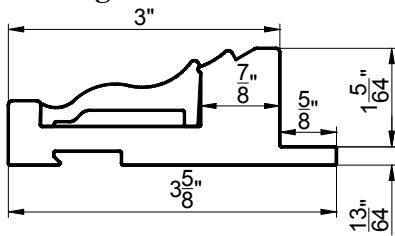

2" Camber Deco Frame

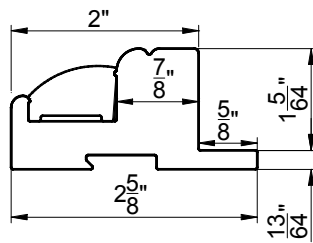

2" Classic Deco Frame

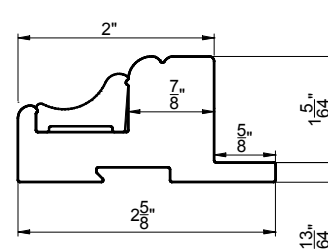

L Frames

Offered as outside mount or inside mount. Outside mount Vintage L Frame with insert comes with predrilled frame. Inside mount does not come with predrilled frame. Please provide Maximum Frame-to-Frame Size when ordering L Frame inside mount.

Beaded L Frame

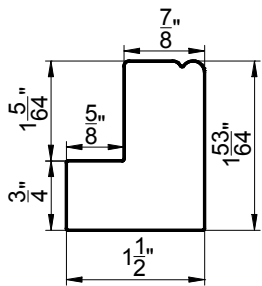

Beaded L Frame w/ 1/2" Buildout

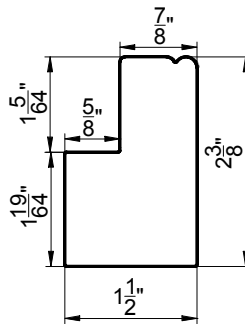

Bullnose L Frame

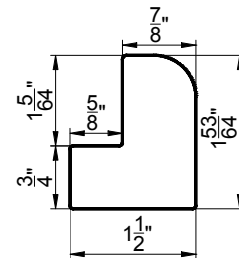

Bullnose L Frame w/ 1/2" Buildout

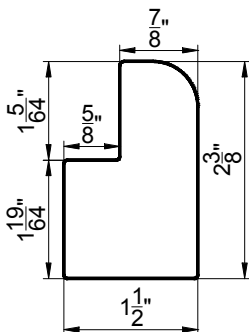

Vintage L Frame

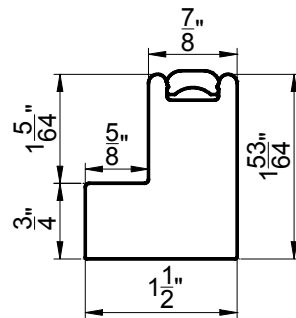

Vintage L Frame w/ 1/2" Buildout

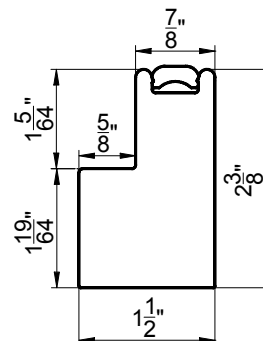

Vintage Hang Strip

Inside or outside mount applications. Two-sided frame comes with two light blocks. Inside mount comes with pre-drilled frame. Light blocks are not pre-drilled.

1" Vintage Hang Strip

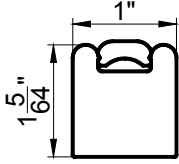

Z Frames

Z frames are offered as inside mount only. Z frames do not come pre-drilled.

3" Crown Z Frame

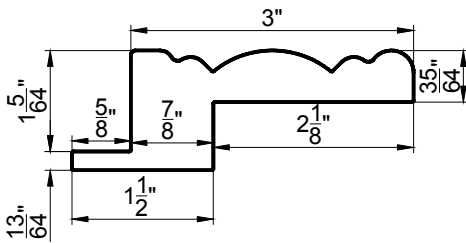

2" Bel Air Z Frame

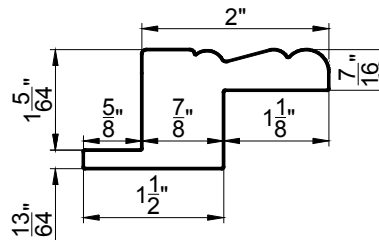

1 1/2" Bullnose Z Frame

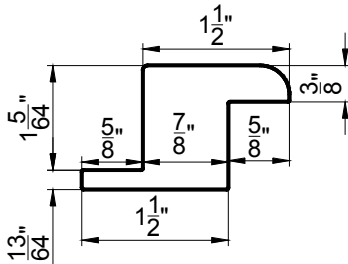

1 1/4" Beaded Z Frame

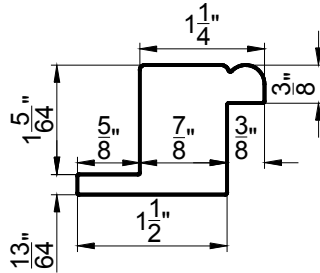

Tilt Out Z Frame

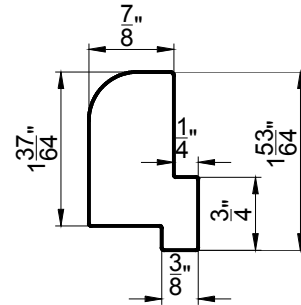

Deco Sill Frames

Deco Sill Frames are a nice addition to give a shutter a consistent look, especially when there is not an existing windowsill. The Deco Sill Frame extends past the frame 1/2", by default, unless you request 1".

3" Deco Sill Frame

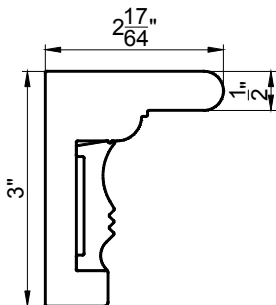

Sill Plates

Sill Plates are a nice addition to give a shutter a consistent look, when there is an existing sill.

3" Ridge Deco Sill Plate

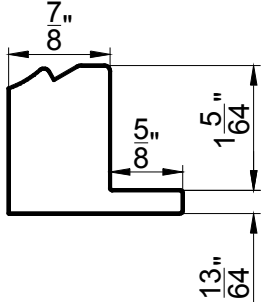

2" Deco Sill Plate

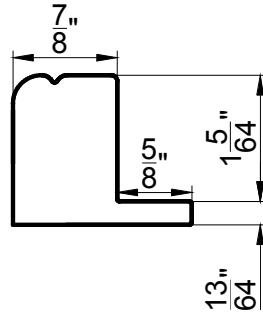

3" Crown Z Sill Plate

7

2" Bel Air Z Sill Plate

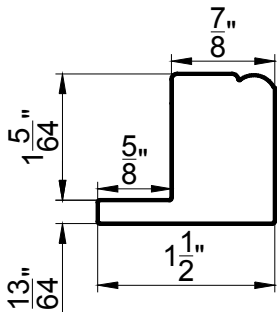

**Sill Plate for 1 1/4" Beaded Z
and 1 1/2" Bullnose Z Frames**

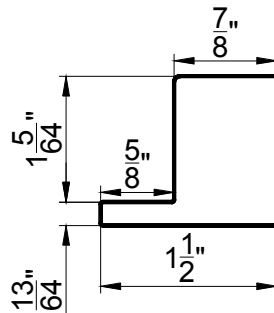

Designer Sill Caps

Designer Sill Caps are a nice addition to give a shutter a consistent look, especially when there is an existing windowsill. The Designer Sill Cap extends past the frame 1/2", by default on each side, unless you request 1".

**Designer Sill Cap
For L Frame**

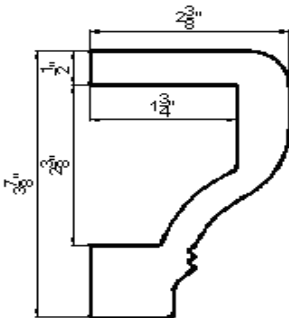

**Designer Sill
For Deco & Hang Strip**

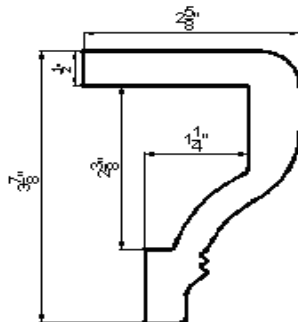

**Cap Designer Sill Cap
For Z Frame**

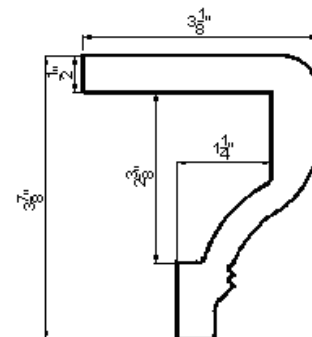

Other Framing Materials

Scribe Trim

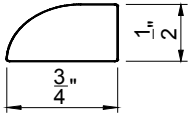

Light Block

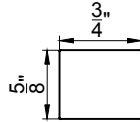

T-Posts

**1 3/4" T-Post For
Deco & Z Frame**

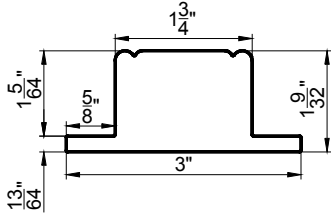

**1 3/4" T-Post For
L Frame & Hang Strip**

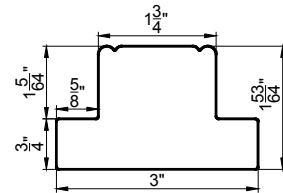

**1" T-Post For
Deco & Z Frame**

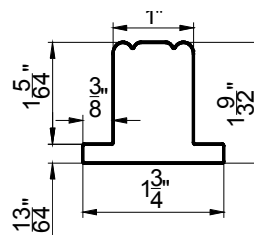

**1" T-Post For
L Frame & Hang Strip**

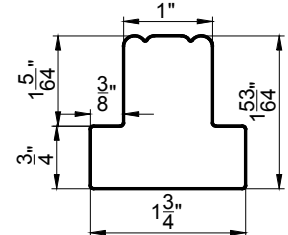

Corner Posts

Standard angle is 90 °; custom angle is available with surcharge.

Corner Post for Deco & Z Frame

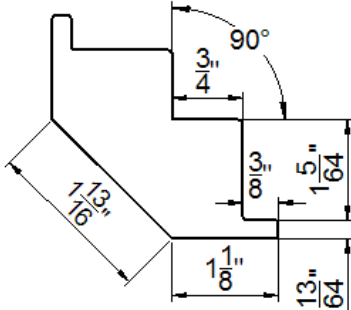

Corner Post for L Frame & Hang Strip

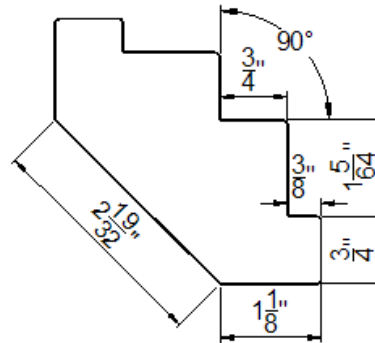

Bay Posts

Standard angle is 135 °; custom angle is available with surcharge.

Bay Post for Deco & Z Frame

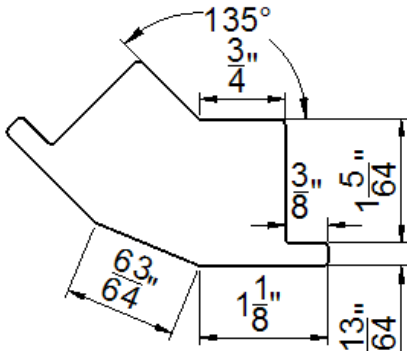

Bay Post for L Frame & Hang Strip

